



## SPIKA MS700-22

115 V / 60 Hz









**3 YEARS**  
WARRANTY  
PARTS & LABOR

### MODULAR 22 INCH ICE CUBE MACHINE

#### FEATURES

- ▶ PRODUCES FULL DICE OR HALF DICE ICE CUBES
- ▶ HIGH EFFICIENCY EVAPORATOR
- ▶ SMART WATER DISTRIBUTOR THAT IMPROVES DROP-OFF EFFICIENCY
- ▶ EASY ACCESS FOR SERVICE BY REMOVING THE PANELS WITH A SINGLE SCREWDRIVER
- ▶ SMART ELECTRONIC BOARD CONTROLS EVERY PARAMETER IN THE MACHINE AND SHOWS THE DIAGNOSIS OF POSSIBLE INCIDENCES
- ▶ HIGH RESISTANCE EXTERNAL FRAME IN AISI 304 STAINLESS STEEL



	 24 H	 70°F/21°C   50°F/10°C lbs (Kg)	 90°F/32°C   70°F/21°C lbs (Kg)	 in (mm)	 in (mm)	 <b>SPIKA HALF DICE</b> 0,9" (W) x 0,4" (D) x 1" (H) 23 mm (W) x 11 mm (D) x 26 mm (H) Average dimensions	 <b>SPIKA FULL DICE</b> 1" (W) x 0,9" (D) x 1" (H) 26 mm (W) x 23 mm (D) x 26 mm (H) Average dimensions
SPIKA MS700-22 H		<b>668</b> (303)	<b>553</b> (251)	Width <b>22"</b> (559) Depth <b>24"</b> (621) Height <b>26"</b> (659)	Width <b>26"</b> (650) Depth <b>28"</b> (710) Height <b>32"</b> (820)		
SPIKA MS700-22 F		<b>676</b> (307)	<b>527</b> (239)				

#### ACCESSORIES

##### INCLUDED



SCOOP



WATER OUTLET HOSE

##### NOT INCLUDED



DOUBLE 10" FILTER  
ANTI-LIMESCALE + ANTI-CHLORINE  
CS102



10" REPLACEMENT CARTRIDGE  
ANTI-LIMESCALE + ANTI-CHLORINE  
CS10

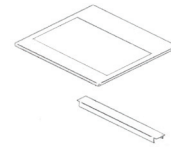

ADAPTER PLATES



SCALE KLEEN

#### RECOMMENDED BINS

##### RECOMMENDED



S400  
+ SPIKA  
MS700-22



SCS350  
+ SPIKA  
MS700-22

##### OTHER POSSIBLE OPTIONS



S500  
+ SPIKA  
MS700-22



S750  
+ SPIKA  
MS700-22



S900  
+ SPIKA  
MS700-22



S1050  
+ SPIKA  
MS700-22



SCS700  
+ SPIKA  
MS700-22



SCD900  
+ 1/2 SPIKA  
MS700-22



SCD1350  
+ 1/2 SPIKA  
MS700-22



SCD1800  
+ 1/2 SPIKA  
MS700-22

# TECHNICAL SCHEME

SPIKA MS700-22

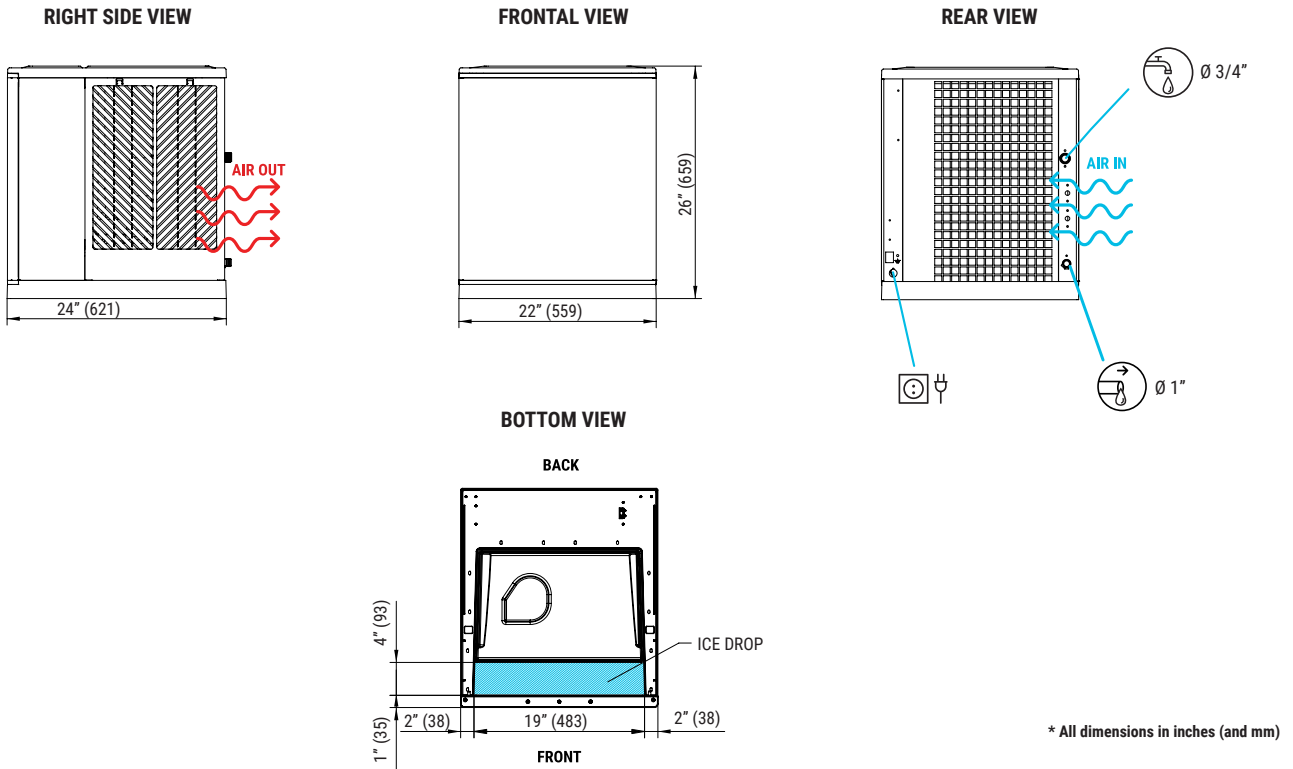

\* All dimensions in inches (and mm)

## OPERATING CONDITIONS

### PRODUCTION (LBS) 60Hz

±10% V

41°F/109°F

41°F/95°F

14.5 psi (1 bar) / 87 psi (6 bar)

240/480 Ice cubes/cycle

V	Hz	ph
115	60	1N



HALF DICE  
SPIKA MS700-22 AIR COOLED

°F	50°	60°	70°	86°
°C	10°	15°	21°	30°
50°	699	694	639	595
68°	668	661	617	573
90°	606	595	553	507
109°	496	485	437	397
43°				



FULL DICE  
SPIKA MS700-22 AIR COOLED

°F	50°	60°	70°	86°
°C	10°	15°	21°	30°
50°	707	703	647	567
68°	676	678	625	546
90°	613	602	527	483
109°	472	462	416	378
43°				

## MODELS

MODEL	ASHRAE CONDITIONS (BTU/h)	(W)	(W) 109°F	(AWG/mm <sup>2</sup> ) (n.)	FUSE	100lbs (Kwh/100 lbs) 90°F / 70°F	gal 100lbs (l/h)	HEAT REJECTED (BTU/h) (W)	(lbs)	(lbs)			
SPIKA MS700-22 A	13.853	4.060	1.300	12/2,5	3	25	5,25	16,56	17,4	8.636	2.531	70,4	82
SPIKA MS700-22 W	13.853	4.060	1.300	12/2,5	3	25	-	-	-	8.636	2.531	70,4	82



ITV Ice Makers, Inc.  
9550 Satellite Blvd, Suite 100  
Orlando, FL 32837  
Phone: 1 407 826 1860 | Fax: 1 407 826 1861  
Toll Free: 1 888 488 1423  
sales@itvice.com | www.itvice.com



SERVICE  
service@itvice.com  
Skype: service@itvice.com  
PHONE: +1 888 488 1423  
FROM 8AM TO 5PM EST



2 ADDITIONAL YEARS ON COMPRESSOR & EVAPORATOR  
Read our warranty policy to know more about limitations and exclusions

